

QA3™

Emergency Stretcher

Radiotranslucent platform with exceptional X-ray access and low height capability



Innovative Medical Technology - **Practically Applied**

AneticAid®

QA3 EMERGENCY STRETCHER SYSTEM



QA3 DRIVE™ Powered Emergency Stretcher

STANDARD FEATURES plus INBUILT MOTORISED DRIVE and POWERED FUNCTIONS

Top of the range model: combines all features of the Standard, DRIVE and Powered Stretchers – the complete answer for moving and positioning patients as easily as possible.

Description	Code
QA3 DRIVE Powered Emergency Stretcher with Radiolucent Platform	21124



Drive handles

Innovative touch sensitive design simply press against the pop-up or fixed yellow pushing handles, and the stretcher will move forward; pull back on them, and it will reverse; let go and it will stop.



Electrically Powered Functions

Easy to operate using the positive feel push button controls on a panel at the foot of the stretcher.

Manual override systems as standard.

Three new models to choose from

QA3 DRIVE™ Emergency Stretcher

STANDARD FEATURES plus INBUILT MOTORISED DRIVE

Featuring inbuilt motorised drive – operated by innovative touch-sensitive pushing handles: controlled, effortless travel up to gradients of 10°

Description	Code
QA3 DRIVE Emergency Stretcher with Radiolucent Platform	21122



QA3™ Emergency Stretcher

STANDARD FEATURES

Specially designed for Emergency Departments with radiolucent platform, offering exceptional X-ray access as well as a medirail and K8 pressure care mattress.

Description	Code
QA3 Emergency Stretcher with Radiolucent Platform	21120



LIFETIME WARRANTY
Subject to annual servicing



QA3™ Emergency Stretcher:

We offer the unique and popular **'Lifetime Warranty Scheme'**

Take out a **AnetiCare** service package for regular and predictable maintenance costs that includes a **10 YEAR WARRANTY**.

Covers engineer's time and most parts contact us to learn more about what an **AnetiCare** service package can offer you.

Available via your Anetic Aid partner – find them at aneticaid.com/distributors.



Combining industry knowledge with innovative technology



Designed and produced at our UK manufacturing facility using the latest engineering techniques



Manufacturer, designer and supplier of high quality medical equipment around the world



Unique manufacturer-backed Lifetime Warranty Scheme

STANDARD FEATURES

Specially designed QA3 Emergency Stretcher features a radiotranslucent platform, exceptional X-ray access and low height capability. Comes complete with a medirail and the K8 pressure care mattress.

With maximum patient comfort built in, the stretcher is supremely manoeuvrable, compact, light weight and robust. All Emergency stretchers are fitted with two fixed transfusion poles and a medirail.



Trendelenburg tilt

Extremely smooth and controlled mechanism, even at lowest height

Vertically operated side rails

Store away under mattress for a virtually zero transfer gap. Spring counterbalancing allows effortless ease of operation

5th wheel steering

Unique mechanism ensures maximum manoeuvrability and easily guided by one person

Patient comfort

Exceptional low height capability and store away side rails allow easy mount/dismount particularly for frail and elderly patients. Wide patient platform and pressure care mattress for patient comfort. Optimum ground clearance for patient hoist access



QA3 DRIVE™
Powered Emergency Stretcher

QA3 DRIVE™
Emergency Stretcher

QA3™
Emergency Stretcher

Pushing handles

Four ergonomically positioned pushing handles for supreme manoeuvrability

Gas assisted backlift

Unique design, precision controlled, easy lift system for enhanced user and patient comfort

Infection control

Smooth moulded surfaces and acrylic capped vac formings enclose stretcher mechanics to minimise dirt traps. Anti-bacterial properties and innovative design for easy cleaning



K8 pressure care mattress

Manufactured from temperature-sensitive gel feel foam that moulds to the patient's body shape, relieving pressure by distributing the load as evenly as possible. Outer material is anti-microbial, water resistant, vapour permeable and latex free

X-ray translucent platform

Full length radiotranslucent platform, suitable for digital or traditional plates

Fixed transfusion poles

Fitted as standard: innovative quick release safety locking mechanism, integrates into either head or foot end of side rails for easy access and storage

Hydraulic lift mechanism

Exceptional low height capability, adjusted by independently operating pedals on both sides of stretcher



Castors

Polyurethane tyres offer low rolling resistance for high manoeuvrability, 150mm castors fitted as standard, 200mm optional

Cylinder trough

Side loading for ease of access, suitable for wide range of cylinder options including F, E or CD

Robust with maximum patient comfort built in



DESIGN & INNOVATION



MADE IN THE UK



GLOBAL DISTRIBUTION

Motorised **DRIVE** FEATURES

QA3 **DRIVE**[™]
Powered Emergency Stretcher

QA3 **DRIVE**[™]
Emergency Stretcher

QA3[™]
Emergency Stretcher

Inbuilt motorised drive offers effortless movement combined with ultimate control.

Because people and therefore patients are getting larger, it's crucial that we take moving and handling issues into account, giving practitioners a stretcher on which patients can be moved and positioned as easily as possible.

The introduction of our new touch-activated, motorised DRIVE feature offers a major enhancement in a Stretcher that already has ease of use, practicality and patient comfort built in.

The Stretcher can also be used in traditional fifth wheel steer mode.



Drive handles

Innovative touch sensitive design simply press against the pop-up or fixed yellow pushing handles, and the stretcher will move forward; pull back on them, and it will reverse; let go and it will stop.

Effortless travel up to gradients of 10°

Inbuilt motorised drive

No need to push or pull the stretcher: our new, inbuilt motorised DRIVE feature linked to the stretcher's 5th wheel, offers controlled, effortless travel up to gradients of 10°.



Long-life battery – 22 kilometers on a single charge

DRIVE feature powered by advanced nickel metal hydride rechargeable battery.



Highly accurate battery charge indicator – rapid charge.



Motorised DRIVE: effortless travel, ultimate control



Another option developed to help minimise risks for practitioners dealing with increasing patient weights is powered positioning.

With these models, either the whole stretcher platform or the backrest can now be raised or lowered electronically from the panel at the foot end.

There's also a special CPR feature: return the stretcher swiftly to a horizontal, optimal height position for CPR treatment, at the touch of a button.

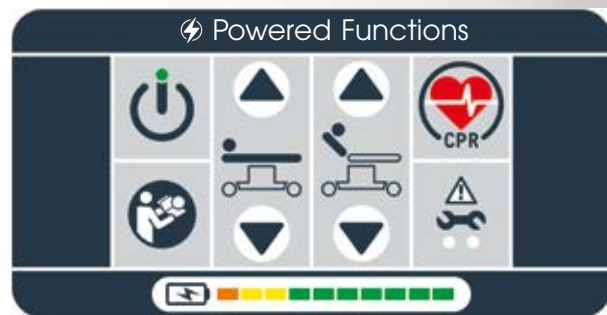

Electrically Powered Functions

Easy to operate using the positive feel push button controls on a panel at the foot of the stretcher.

Manual override systems as standard.

Platform height – electrically powered raise and lower mechanism

Offers smooth movement to position the stretcher at any point in its height range – 535mm to 835mm (excluding mattress)

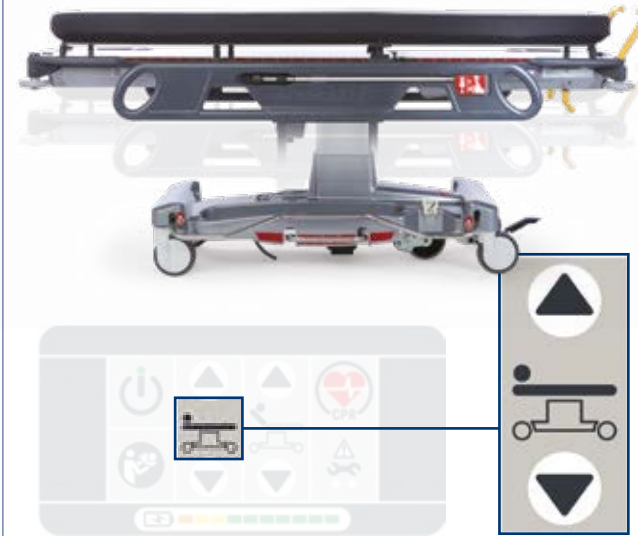

Backrest – electrically powered raise and lower mechanism

Positions the backrest anywhere between the vertical and horizontal for maximum patient comfort

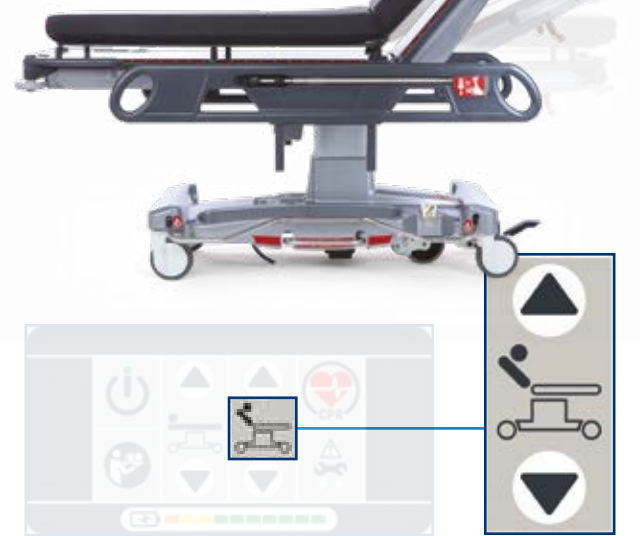

Lights on the power panel illuminate to refer the user to the manual if the equipment is being used incorrectly or to indicate when maintenance is required

If a patient needs CPR treatment, there is no time to lose: the powered CPR feature returns the stretcher swiftly to a horizontal, optimal height position for CPR treatment

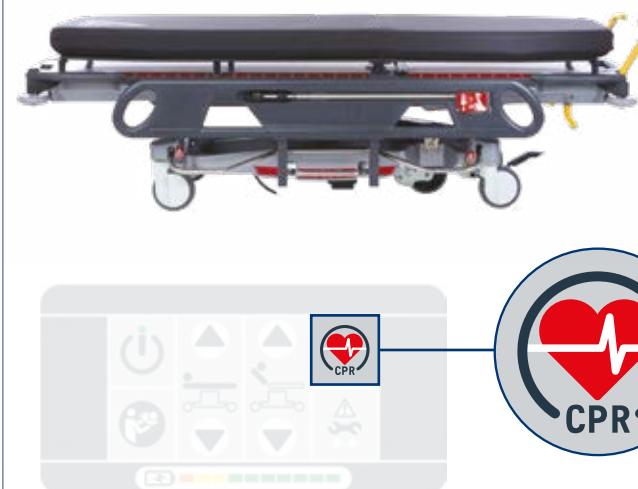

Trendelenburg – hydraulically powered tilt mechanism

Extremely smooth and controlled movement, even at the stretcher's lowest height



Special features for a stretcher that's more powerful, by design



DESIGN & INNOVATION



MADE IN THE UK



GLOBAL DISTRIBUTION

ACCESSORIES

K8 Pressure Care Mattresses

Pressure care and infection control are top priorities in a stretcher mattress – and Anetic Aid's independently tested K8 pressure care mattress addresses both of these vital factors.

At its core is high density foam, uniquely specified by Anetic Aid. This means that the mattress can be thinner, while still offering the same, if not better, pressure distribution than a thicker, less sophisticated foam. This is particularly important with tables and Stretchers, as it means the overall height can be kept as low as possible for easy access by frail or elderly patients.

A layer of thermally responsive gel-feel memory foam is then added, further relieving pressure by distributing the patient's weight as evenly as possible across the surface area – whatever their position.



In the science of Kinetics, there are eight points of contact the human body makes when lying on a hard surface – hence K8.

Description	Code
QA3 K8 Pressure Care Mattress with Zip Cover	21186
QA3 K8 Pressure Care Mattress – Replacement Waterproof Zip Cover	21186-B1



Anetic Aid's K8 technology mattresses can be found in over 90% of NHS hospitals in the UK.

K8 Mattress **Normal Mattress**

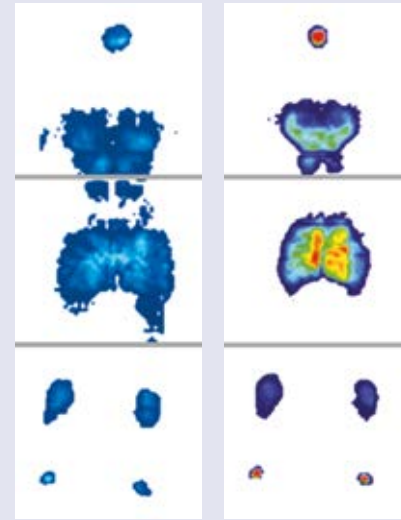

High risk pressure care mattress

Independently tested

Latex free

Antibacterial / vapour permeable

Welded seams

X-ray translucent

Infection control

Both of the foam elements of the mattress have antibacterial and microbial fungistatic properties – but Anetic Aid goes further, adding a latex-free, 4-way stretch polyurethane (PU) outer cover to each mattress (most materials being 2-way stretch), which is anti-microbial, water resistant and vapour permeable.

This means it is not only contamination-resistant, but it also allows the skin to breathe – for greater patient comfort.

Finally, a unique ultrasonic sealing system effectively welds the seams of the outer cover material together to give an almost unbreakable seal, making the K8 a class leader in infection control.

QA3 // // // DRIVE™
Powered Emergency Stretcher

QA3 // // // DRIVE™
Emergency Stretcher

QA3™
Emergency Stretcher

Additional products for all QA3 Stretcher models

Specially designed and manufactured accessories for QA3 Patient and Emergency Stretcher Systems.



21152



21152-A1



21390



21153



21189



10545

Description	Code
Monitor Shelf c/w Removable Refreshment Tray	21152
Refreshment Tray ONLY	21152-A1
QA3 Foot-end Extension c/w 100mm Pad	21153
Theatre Pillow	10545
QA3 Foot-end Mattress Protector	21189
QA3 and QA4 Stretcher Systems Push / Pull Bar	21390

Accessories for radiographers

As well as our Lateral Cassette holder, we offer three additional items to aid patient positioning and help radiographers achieve the best possible image outcomes.



21195-B1



21195-C1



21195-A1

Description	Code
QA3 Emergency Stretcher Radiographic Cassette Carrier Tray	21195-A1
QA3 Emergency Modified Axial (Wallace) View Support	21195-B1
QA3 Emergency Stretcher X-ray Cassette Support Shelf	21195-C1

Wallace Support – Facilitates positioning of cassette for Modified Axial (Wallace) View patient shoulder X-rays. Consists of two props which attach to Side Rail with spring-loaded quick release handles.

Carrier Tray – Allows for easier loading and positioning of detectors (cassettes) – while also helping to protect them from accidental damage.

Support Shelf – For easy and secure positioning of cassette for patient chest X-rays.

Customise the QA3™ to suit your departments requirements with our range of accessories.



OUR PRODUCT AREAS



QA4 Mobile Surgery System:

The complete multi-purpose solution for transport, treatment and recovery

PLUS

our other product areas



Scan this code to start a WhatsApp chat with Anetic Aid

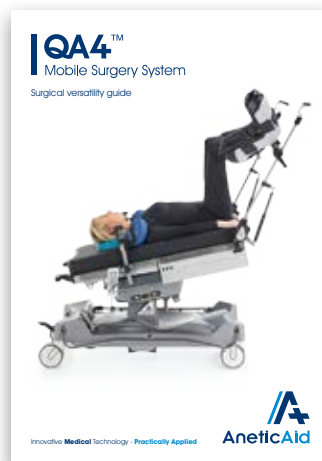
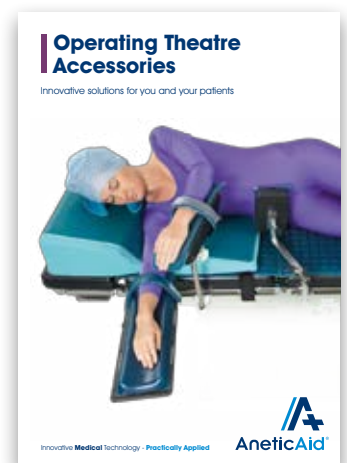
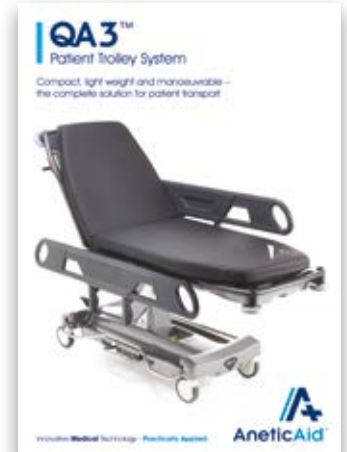

For more information on any of our products or service contracts, call:
sales@aneticaid.com **+44 (0)1943 878647** aneticaid.com



DESIGN & INNOVATION



MADE IN THE UK



GLOBAL DISTRIBUTION

Innovative **Medical** Technology - **Practically Applied**

